



Product Name:	Cell Culture Plate
Product Application:	For cell culture and cell biology research experiments. Tissue treated and non-treated are both available. Non-treated growth surface is more hydrophobic than tissue culture surface and are similar to the surface of a bacteriological Petri dish.
Product Materials:	Polystyrene (PS), meets USP, Class VI standards.
product Specifications:	Temperature range: stored at room temperature Shelf life: 3 Years after date of production (ensure package is in good)
Sterilization:	Yes. Sterilized by E-beam, Sterility Assurance Level: SAL=10 ⁻⁶ . The product has been irradiated and dosimetrically released based on ANSI/AAMI/ISO 11137
Pyrogens:	Non-Pyrogenic
RNase/DNase:	DNase/RNase free
BSE/TSE:	These products are deemed animal free.
Performance Testing:	Each manufacturing lot is sampled and tested in accordance with standard operating procedures. Appearance inspection: qualified Flatness test: qualified Hydrophilic test: qualified Cell culture test: qualified Packaging inspection: qualified
Features	<ol style="list-style-type: none"> Excellent design: NEST cell culture plates have round edges for better handling. Low profile, low-evaporation lid design assures uniform growth. Tissue treated and non-treated are both available. Small feet on the bottom corners of each plate eliminate scraping of the microscope lens. Markings of well coordinates available for 12, 24, 48, 96 and 384 well plates TC treated: Vacuum Plasma tissue culture treatment, better hydrophilicity for adherent cell culture. Non-treated growth surface is more hydrophobic than tissue culture surface and are similar to the surface of a bacteriological Petri dish. Various packaging types:
	<div style="display: flex; justify-content: space-around; align-items: flex-end;"> <div style="text-align: center;">  <p>Individually Wrapped in Peelable Tyvek Films and Blisters</p> </div> <div style="text-align: center;">  <p>Bulk, Individually plastic wrapped</p> </div> <div style="text-align: center;">  <p>Bulk, 10 qty/pk.</p> </div> </div>

Head Office No. 530, Xida Road, Meicun Industrial Park, Xinwu District, Wuxi, Jiangsu, China
Tel: +86+ 510-6800 6788 Email: info@nest-wuxi.com
Online: www.cell-nest.com

Oversea NEST USA (New Jersey/ Phoenix)
NEST scientific 株式会社 (Yokohama, Japan)
NEST Scientific Europe B.V (Netherlands)
Nest Scientific (MENA) FZE (Sharjah, United Arab Emirates)

5. Advantage of Low EVAP EDGE Plates:

Compare with Common Cell Culture Plate, Grooves are designed at the edge of the culture plate to avoid the edge effect to the greatest extent, and to ensure that the cells maintain their optimal state during cell culture.

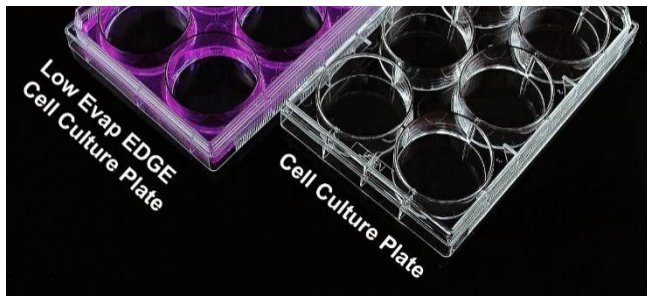

Product Range

Individually Wrapped in Peelable Tyvek Films and Blisters

TC Cat. No.	Non-treated Cat.No.	Product Description	/Pack	/Case
703001	703011	6 Well Cell Culture Plate, Flat-bottom, Clear	1	50
712001	712011	12 Well Cell Culture Plate, Flat-bottom, Clear	1	50
702001	702011	24 Well Cell Culture Plate, Flat-bottom, Clear	1	50
748001	748011	48 Well Cell Culture Plate, Flat-bottom, Clear	1	50
701001	701011	96 Well Cell Culture Plate, Flat-bottom, Clear	1	100
701101	701111	96 Well Cell Culture Plate, U-bottom, Clear	1	100
701201	701211	96 Well Cell Culture Plate, V-bottom, Clear	1	100
761001	761011	384 Well Cell Culture Plate, Flat-bottom, Clear	1	100
761301	761311	384 Well Cell Culture Plate, Flat-bottom, Black	1	100
761601	761611	384 Well Cell Culture Plate, Flat-bottom, White	1	100
714011	714001	6 Well Low Evap EDGE Cell Culture Plate, Flat-bottom, Clear	1	50
713011	713001	96 Well Low Evap EDGE Cell Culture Plate, Flat-bottom	1	100
701301	701311	96 Well Cell Culture Plate, Flat bottom, White, Sterile	1	100

Bulk, Individually plastic wrapped

TC Cat. No.	Product Description	/Pack	/Case
703003	6 Well Cell Culture Plate, Flat-bottom, Clear	1	50

Head Office No. 530, Xida Road, Meicun Industrial Park, Xinwu District, Wuxi, Jiangsu, China
 Tel: +86+ 510-6800 6788 Email: info@nest-wuxi.com
 Online: www.cell-nest.com

Oversea NEST USA (New Jersey/ Phoenix)
 NEST scientific 株式会社 (Yokohama, Japan)
 NEST Scientific Europe B.V (Netherlands)
 Nest Scientific (MENA) FZE (Sharjah, United Arab Emirates)

712003	12 Well Cell Culture Plate, Flat-bottom, Clear	1	50
702003	24 Well Cell Culture Plate, Flat-bottom, Clear	1	50
748003	48 Well Cell Culture Plate, Flat-bottom, Clear	1	50
701003	96 Well Cell Culture Plate, Flat-bottom, Clear	1	100
761003	384 Well Cell Culture Plate, Flat-bottom, Clear	1	100

Bulk, 10 qty/pk

TC Cat. No.	Non-treated Cat.No.	Product Description	/Pack	/Case
703002	703012	6 Well Cell Culture Plate, Flat-bottom, Clear	10	50
712002	712012	12 Well Cell Culture Plate, Flat-bottom, Clear	10	50
702002	702012	24 Well Cell Culture Plate, Flat-bottom, Clear	10	50
748002	748022	48 Well Cell Culture Plate, Flat-bottom, Clear	10	50
701002	701012	96 Well Cell Culture Plate, Flat-bottom, Clear	10	100
761002	761012	384 Well Cell Culture Plate, Flat-bottom, Clear	10	100

Recommend:

Product Type	Cell Growth Area (cm ²)	Recommended Medium Volume (mL)
6 Well Cell Culture Plate	9.5	1.9~2.9
12 Well Cell Culture Plate	3.6	0.76~1.14
24 Well Cell Culture Plate	1.9	0.38~0.57
48 Well Cell Culture Plate	0.88	0.19~0.285
96 Well Cell Culture Plate, Flat-bottom	0.32	0.1~0.2
384 Well Cell Culture Plate	0.11	0.025~0.05
96 Well Cell Culture Plate, U-bottom	0.66	0.1-0.2
96 Well Cell Culture Plate, V-bottom	0.41	0.1-0.2

Technical Drawing

6 well cell culture plate

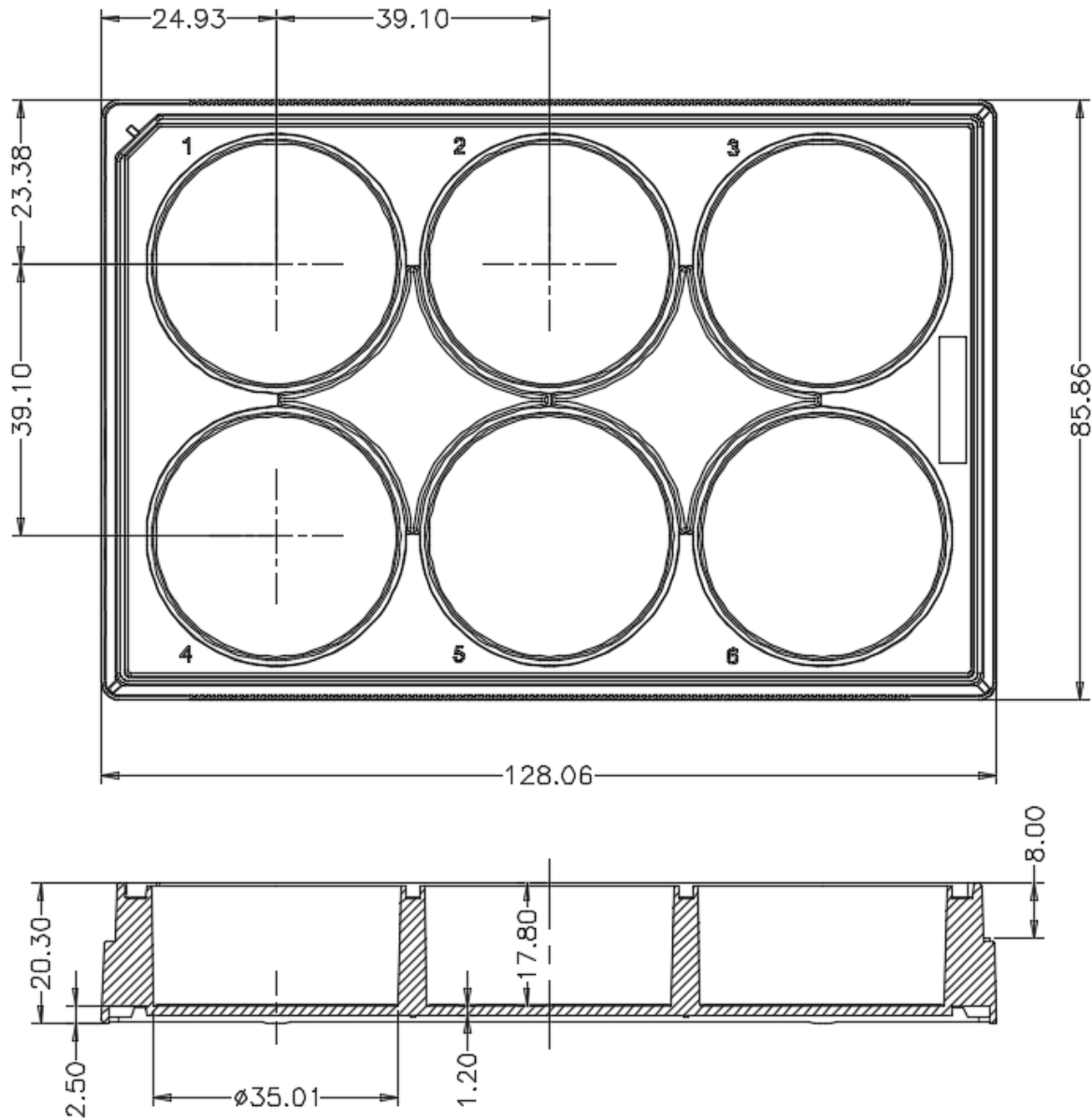

Head Office No. 530, Xida Road, Meicun Industrial Park, Xinwu District, Wuxi, Jiangsu, China
 Tel: +86+ 510-6800 6788 Email: info@nest-wuxi.com
 Online: www.cell-nest.com

Oversea NEST USA (New Jersey/ Phoenix)
 NEST scientific 株式会社 (Yokohama, Japan)
 NEST Scientific Europe B.V (Netherlands)
 Nest Scientific (MENA) FZE (Sharjah, United Arab Emirates)

12 well cell culture plate

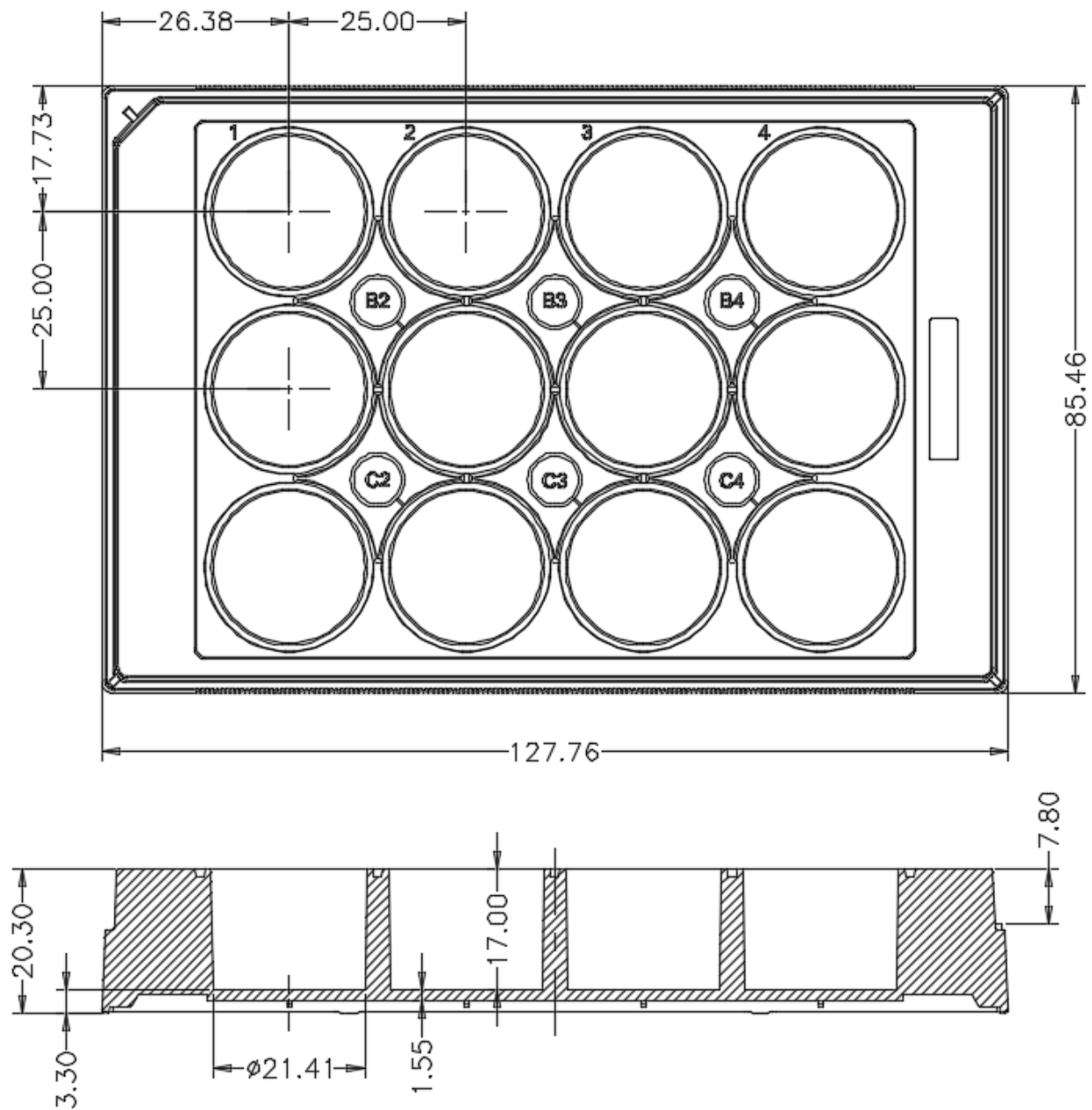

Head Office No. 530, Xida Road, Meicun Industrial Park, Xinwu District, Wuxi, Jiangsu, China
 Tel: +86+ 510-6800 6788 Email: info@nest-wuxi.com
 Online: www.cell-nest.com

Oversea NEST USA (New Jersey/ Phoenix)
 NEST scientific 株式会社 (Yokohama, Japan)
 NEST Scientific Europe B.V (Netherlands)
 Nest Scientific (MENA) FZE (Sharjah, United Arab Emirates)

24 well cell culture plate

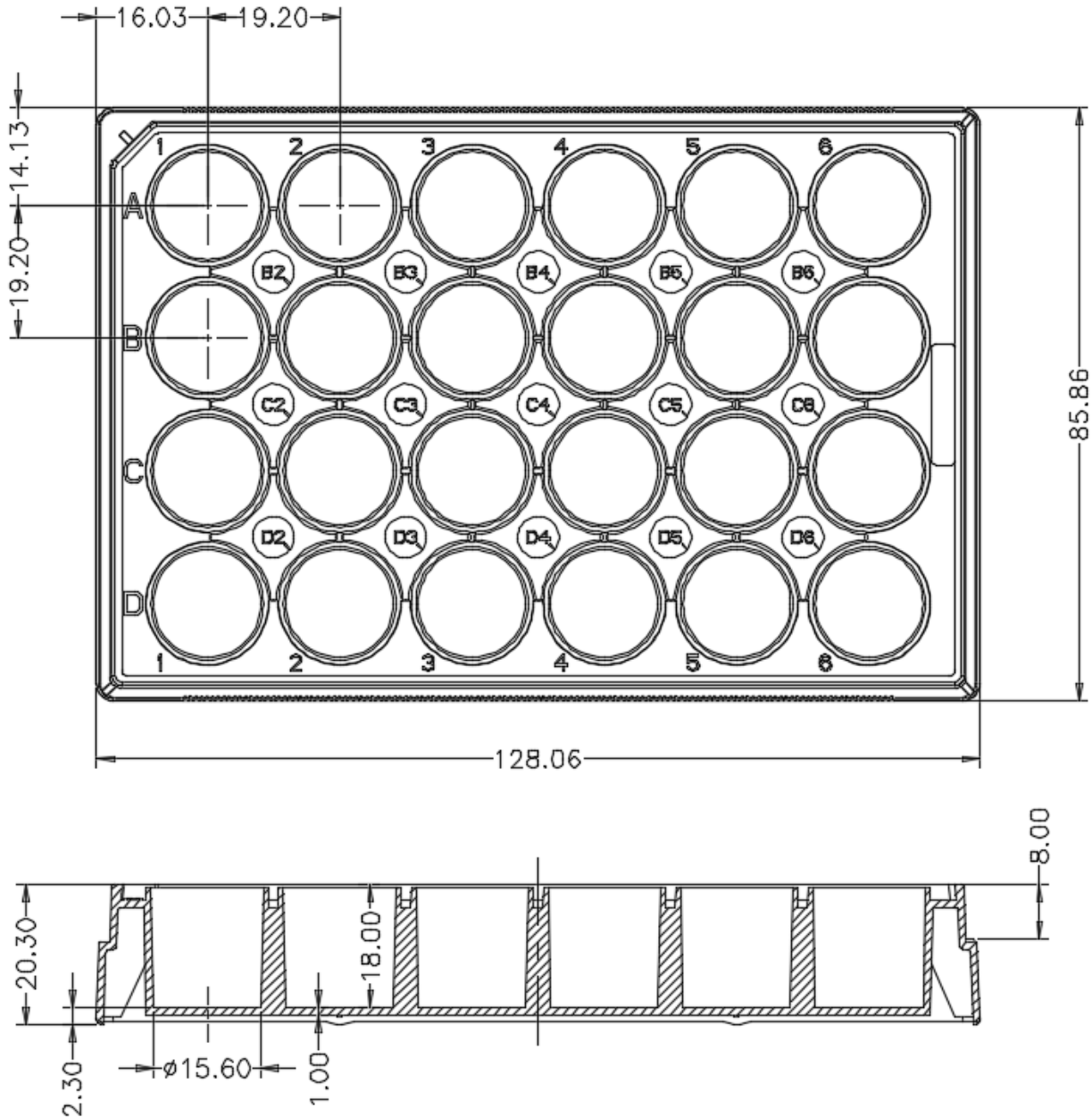

Head Office No. 530, Xida Road, Meicun Industrial Park, Xinwu District, Wuxi, Jiangsu, China
 Tel: +86+ 510-6800 6788 Email: info@nest-wuxi.com
 Online: www.cell-nest.com

Oversea NEST USA (New Jersey/ Phoenix)
 NEST scientific 株式会社 (Yokohama, Japan)
 NEST Scientific Europe B.V (Netherlands)
 Nest Scientific (MENA) FZE (Sharjah, United Arab Emirates)

48 well cell culture plate

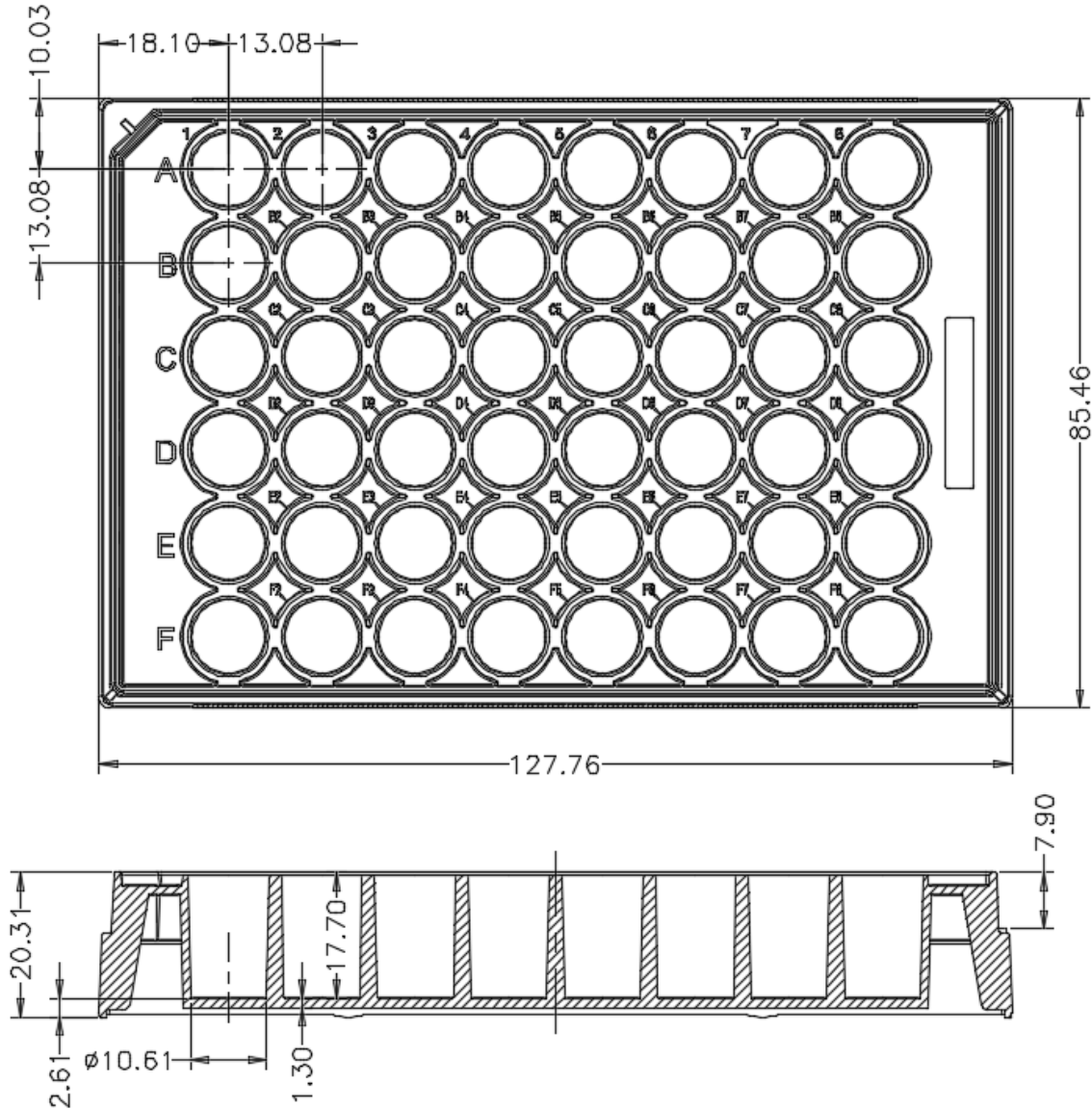

Head Office No. 530, Xida Road, Meicun Industrial Park, Xinwu District, Wuxi, Jiangsu, China
 Tel: +86+ 510-6800 6788 Email: info@nest-wuxi.com
 Online: www.cell-nest.com

Oversea NEST USA (New Jersey/ Phoenix)
 NEST scientific 株式会社 (Yokohama, Japan)
 NEST Scientific Europe B.V (Netherlands)
 Nest Scientific (MENA) FZE (Sharjah, United Arab Emirates)

96 well cell culture plate
Flat bottom

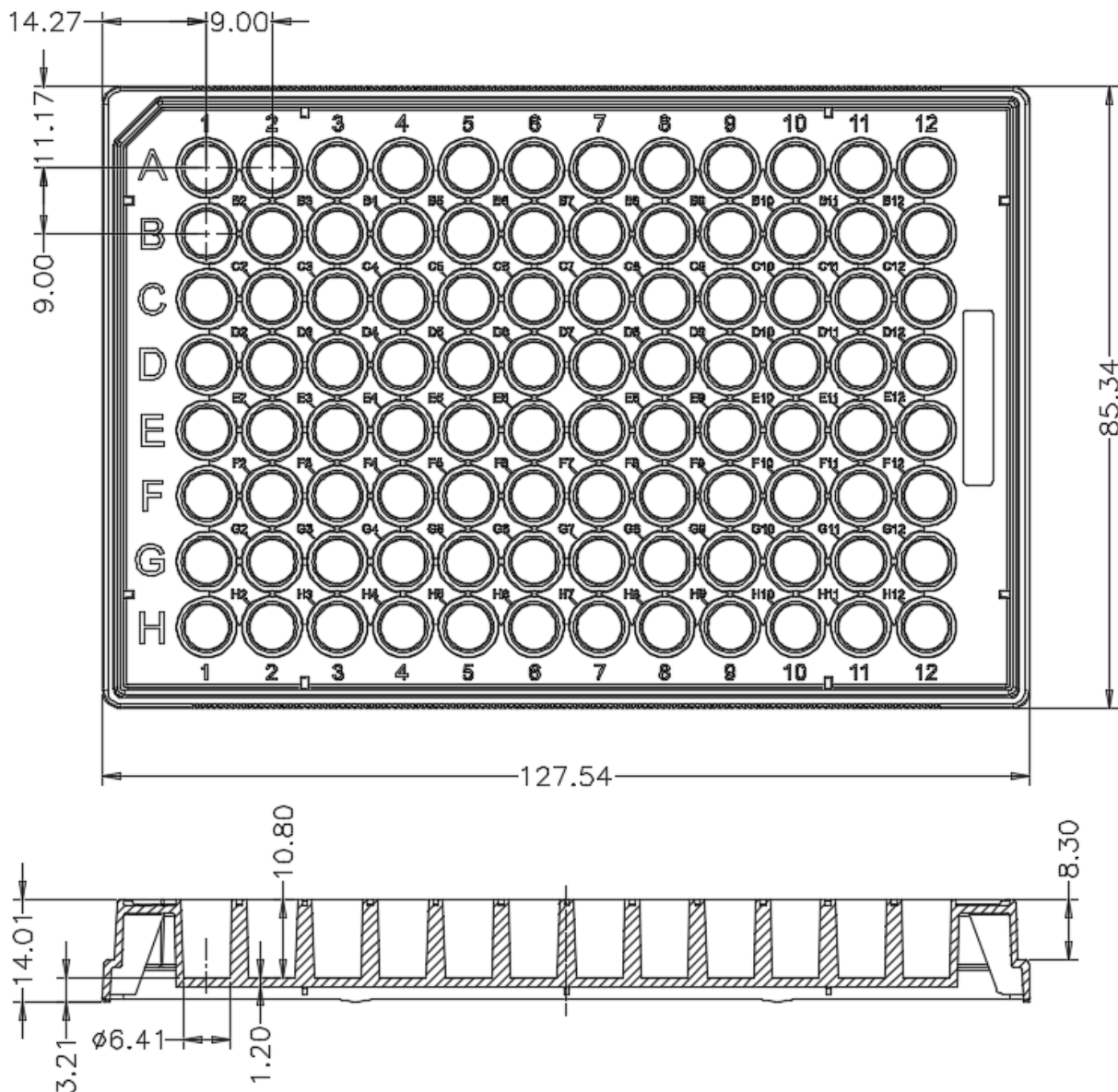

Head Office No. 530, Xida Road, Meicun Industrial Park, Xinwu District, Wuxi, Jiangsu, China
Tel: +86+ 510-6800 6788 Email: info@nest-wuxi.com
Online: www.cell-nest.com

Oversea NEST USA (New Jersey/ Phoenix)
NEST scientific 株式会社 (Yokohama, Japan)
NEST Scientific Europe B.V (Netherlands)
Nest Scientific (MENA) FZE (Sharjah, United Arab Emirates)

96 well cell culture plate
U-bottom

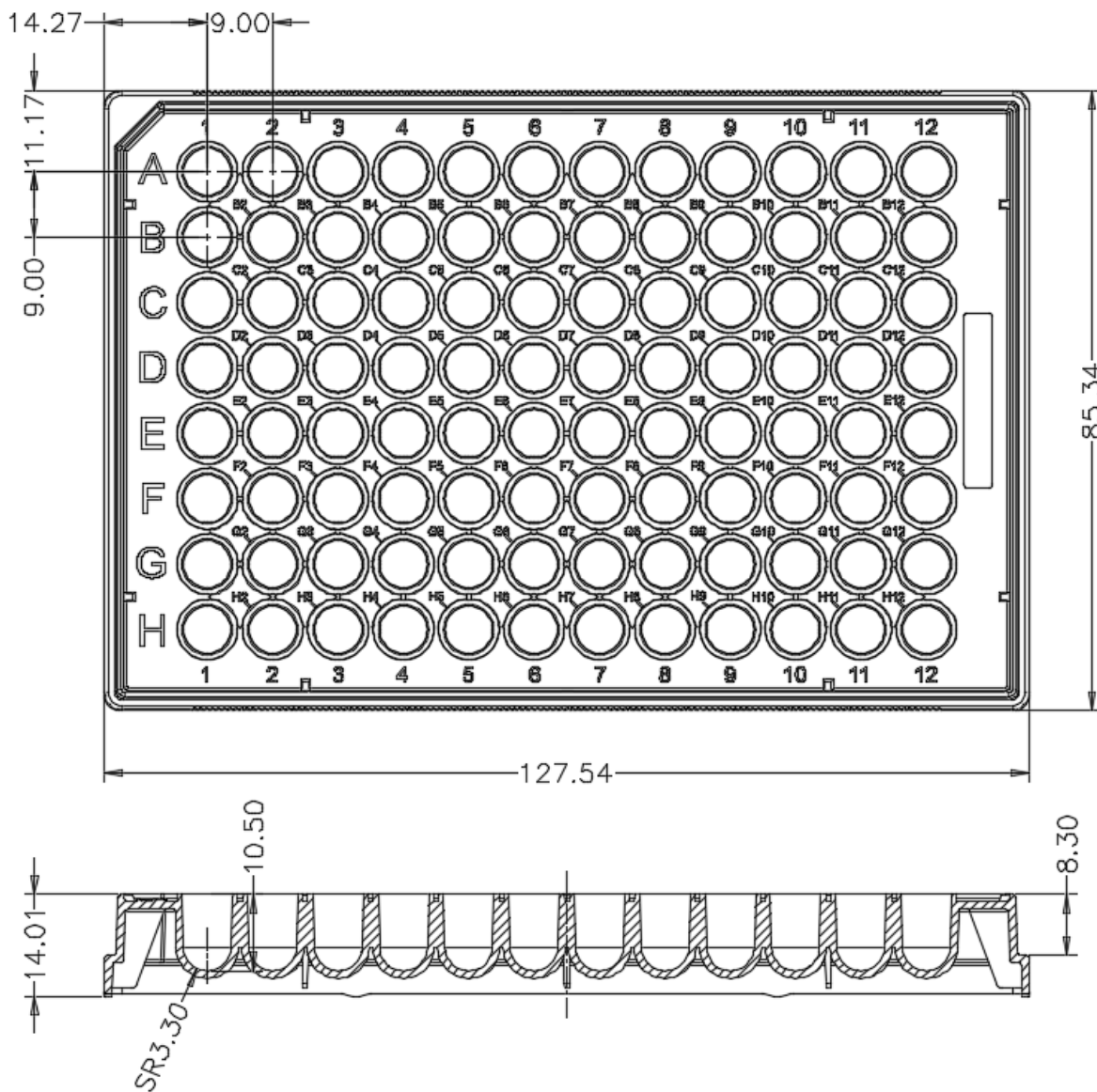

Head Office No. 530, Xida Road, Meicun Industrial Park, Xinwu District, Wuxi, Jiangsu, China
Tel: +86+ 510-6800 6788 Email: info@nest-wuxi.com
Online: www.cell-nest.com

Oversea NEST USA (New Jersey/ Phoenix)
NEST scientific 株式会社 (Yokohama, Japan)
NEST Scientific Europe B.V (Netherlands)
Nest Scientific (MENA) FZE (Sharjah, United Arab Emirates)

96 well cell culture plate
V-bottom

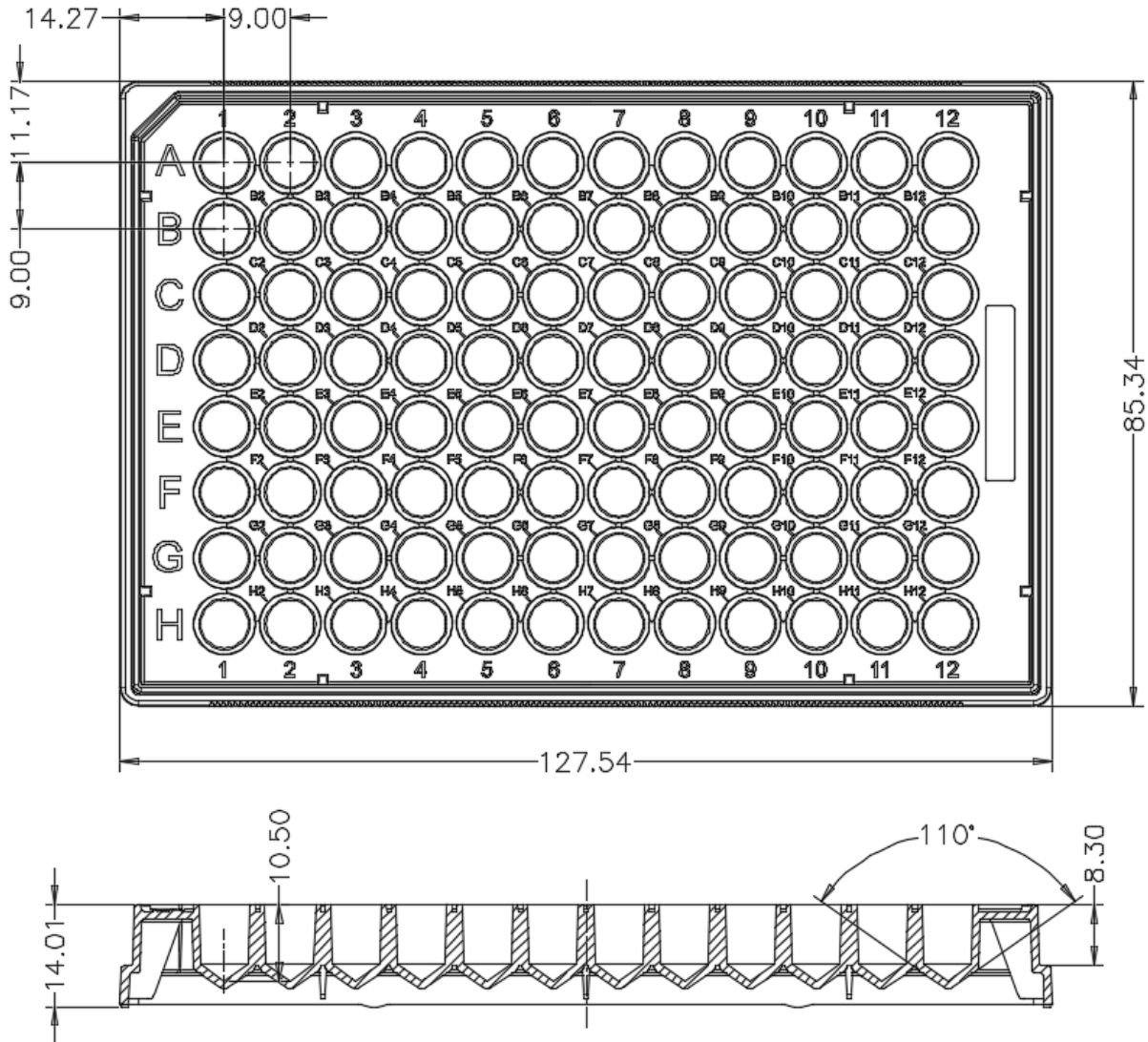

Head Office No. 530, Xida Road, Meicun Industrial Park, Xinwu District, Wuxi, Jiangsu, China
Tel: +86+ 510-6800 6788 Email: info@nest-wuxi.com
Online: www.cell-nest.com

Oversea NEST USA (New Jersey/ Phoenix)
NEST scientific 株式会社 (Yokohama, Japan)
NEST Scientific Europe B.V (Netherlands)
Nest Scientific (MENA) FZE (Sharjah, United Arab Emirates)

384 well cell culture plate

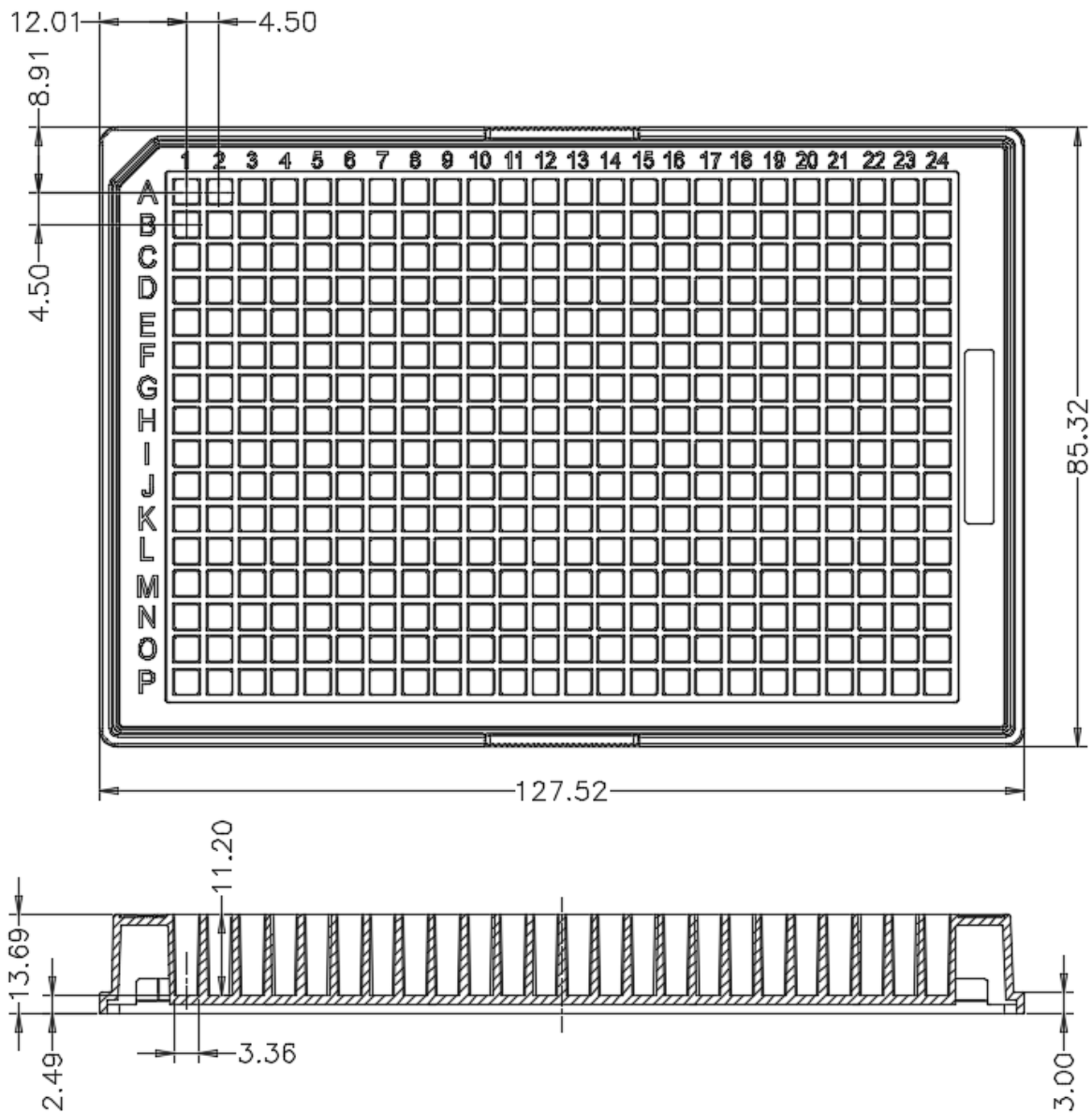

Head Office No. 530, Xida Road, Meicun Industrial Park, Xinwu District, Wuxi, Jiangsu, China
 Tel: +86+ 510-6800 6788 Email: info@nest-wuxi.com
 Online: www.cell-nest.com

Oversea NEST USA (New Jersey/ Phoenix)
 NEST scientific 株式会社 (Yokohama, Japan)
 NEST Scientific Europe B.V (Netherlands)
 Nest Scientific (MENA) FZE (Sharjah, United Arab Emirates)